

Fancy Stones & Settings

Summary

<<<

1	2	3	S		1	2	3	S		1	2	3	S	
				4120 6x4, 8x6, 14x10, 18x13, 25x18 mm					4470 10, 12, 18 mm					4737 14, 20, 30 mm
				4127 30x22, 39x28 mm				*	4500 3x2, 6x2, 10x3 mm				*	4739 14x11, 20x16 mm
				4128** 6x4, 8x6, 10x8, 14x10 mm					4501 4x2, 5x2, 5x2.5, 7x3, 10x5 mm				*	4744 6, 10 mm
				4137 15x11, 22x16, 33x24 mm					4502 3x1 mm				*	4745 5, 10 mm
				4139 14, 20, 30 mm					4527 8x6, 14x10, 18x13 mm				*	4756 19x11.5, 27x16, 39x23.5 mm
				4161 15x5, 21x7, 27x9 mm					4547 15x5, 21x7, 24x8, 30x10 mm				*	4757 14x8.5, 19x11.5 mm
			*	4200 11x3, 15x4 mm				*	4565 14x10, 18x13 mm				*	4759 28x24, 38x33 mm
				4227 32x17 mm				*	4581 24x16 mm					4760 14x8, 18x10.5, 22x12.5 mm
			*	4228 4x2, 5x2.5, 6x3, 8x4, 10x5, 15x7 mm				*	4582 24x16 mm					4787 19x13, 27x19 mm
				4320 6x4, 8x6, 10x7, 14x10, 18x13 mm				*	4583 24x16 mm					4790 18x7.5, 23x10, 32x13.5 mm
				4327 30x20, 40x27 mm				*	4584 24x16 mm				*	4800 5.5x5, 6.6x6, 8.8x8, 11x10, 15.4x14 mm
			*	4328 6x3.6, 8x4.8, 10x6, 13x7.8 mm				*	4600 6x4, 8x6, 10x8, 12x10 mm					4827 28 mm
				4335 3.5 mm					4610 14x10, 18x13, 20x15 mm				*	4831 5.5x5, 8.8x8, 11x10 mm
			*	4370 11x10, 15.5x14, 20x18 mm					4627 27x18.5, 37x25.5 mm					4835 3.5 mm
				4428 2, 3, 4, 5, 6, 8 mm				*	4675 23 mm					4841 4, 6, 8 mm
				4437 14, 20, 30 mm				*	4704 5 mm					4842 4, 6 mm
				4439 14, 20, 30 mm				*	4722 4, 6, 8, 10 mm					4854 6, 8, 10 mm
				4447 6, 8, 10, 12 mm					4727 23 mm					4869 4, 6, 8, 10, 12, 14 mm
				4461 8, 12, 16 mm					4735 3.5 mm					

* More settings planned for these shapes

** Available as of September 2010! Until September 2010 art. 4100 is still available (please refer to former Collection for product details).

— ... Setting available

1 Top View 2 Side View 3 Back View S Setting

Fancy Stones & Settings



Fancy Stones & Settings

4120

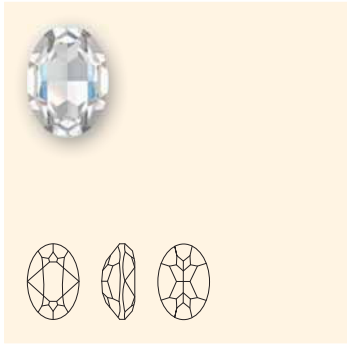

Size	6x4 mm	8x6 mm	14x10 mm	18x13 mm	25x18 mm
------	--------	--------	----------	----------	----------

Colour

<input type="checkbox"/> Crystal F (001)	■	■	■	■	■
<input type="checkbox"/> Crystal Golden Shadow F (001 GSHA)	■	■	■	■	New!
<input type="checkbox"/> Crystal Metallic Light Gold F (001 MLGLD)	■	■	■	■	
<input type="checkbox"/> Crystal Moonlight F (001 MOL)	■	■	■	■	New!
<input type="checkbox"/> Crystal Silver Shade F (001 SSHA)	■	■	■	■	New!
<input type="checkbox"/> Jet (280)	■	■	■	■	■
<input type="checkbox"/> Air Blue Opal F (285)	■	■	■	■	■
<input type="checkbox"/> Amethyst F (204)	■	■	■	■	New!
<input type="checkbox"/> Aquamarine F (202)	■	■	■	■	New!
<input type="checkbox"/> Black Diamond F (215)	■	■	■	■	New!
<input type="checkbox"/> Burgundy F (515)	■	■	■	■	New!
<input type="checkbox"/> Chrysolite F (238)	■	■	■	■	■
<input type="checkbox"/> Cyclamen Opal F (398)	■	■	■	■	■
<input type="checkbox"/> Dark Indigo F (288)	■	■	■	■	■
<input type="checkbox"/> Emerald F (205)	■	■	■	■	New!
<input type="checkbox"/> Erinite F (360)	■	■	■	■	New!
<input type="checkbox"/> Fern Green F (291)	New!	■	■	■	■
<input type="checkbox"/> Fuchsia F (502)	■	■	■	■	■
<input type="checkbox"/> Greige F (284)	■	■	■	■	■
<input type="checkbox"/> Indian Sapphire F (217)	■	■	■	■	New!
<input type="checkbox"/> Indicolite F (379)	■	■	■	■	New!
<input type="checkbox"/> Jonquil F (213)	■	■	■	■	■
<input type="checkbox"/> Khaki F (550)	■	■	■	■	■
<input type="checkbox"/> Light Amethyst F (212)	■	■	■	■	New!
<input type="checkbox"/> Light Azure F (361)	■	■	■	■	New!
<input type="checkbox"/> Light Peach F (362)	■	■	■	■	■
<input type="checkbox"/> Light Rose F (223)	■	■	■	■	■
<input type="checkbox"/> Light Smoked Topaz F (221)	■	■	■	■	New!
<input type="checkbox"/> Light Topaz F (226)	■	■	■	■	New!
<input type="checkbox"/> Mocca F (286)	■	■	■	■	New!
<input type="checkbox"/> Montana F (207)	■	■	■	■	New!
<input type="checkbox"/> Pacific Opal F (390)	■	■	■	■	■
<input type="checkbox"/> Padparadscha F (542)	■	■	■	■	■
<input type="checkbox"/> Peridot F (214)	■	■	■	■	■
<input type="checkbox"/> Provence Lavender (283)	■	■	■	■	■
<input type="checkbox"/> Purple Velvet F (277)	■	■	■	■	■
<input type="checkbox"/> Rose F (209)	■	■	■	■	■
<input type="checkbox"/> Rose Water Opal F (395)	■	■	■	■	■
<input type="checkbox"/> Sand Opal F (287)	■	■	■	■	■

4120



Size	6x4 mm	8x6 mm	14x10 mm	18x13 mm	25x18 mm
------	--------	--------	----------	----------	----------

Colour

<input type="checkbox"/> Sapphire F (206)	■	■	■	■	■
<input type="checkbox"/> Siam F (208)	■	■	■	■	■
<input type="checkbox"/> Smoked Topaz F (220)	■	■	■	■	New!
<input type="checkbox"/> Smoky Quartz F (225)	■	■	■	■	New!
<input type="checkbox"/> Tanzanite F (539)	■	■	■	■	New!
<input type="checkbox"/> Topaz F (203)	■	■	■	■	■
<input type="checkbox"/> Vintage Rose F (319)	■	■	■	■	New!
<input type="checkbox"/> Violet F (371)	■	■	■	■	■
<input type="checkbox"/> White Alabaster F (281)	■	■	■	■	■
<input type="checkbox"/> White Opal F (234)	■	■	■	■	■

4120/S

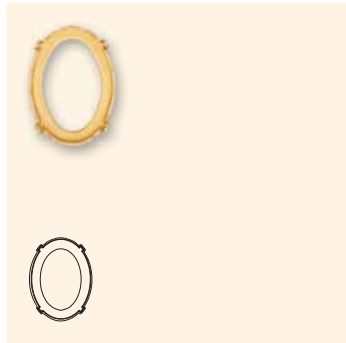

Size	14x10 mm	18x13 mm
------	----------	----------

Ring/Hole, Back Configuration

<input type="checkbox"/> 00 C = No ring/hole, closed	■	■
<input type="checkbox"/> H2 O = 4 holes/2 each side, open	■	■



00 C



H2 O

Fancy Stones & Settings

4127

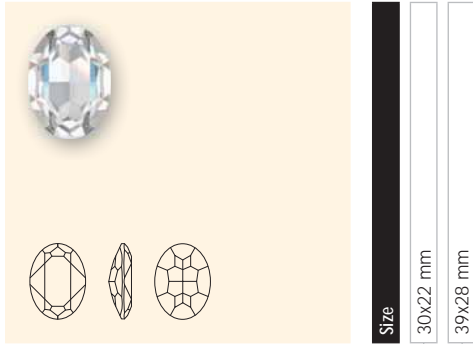

Size
30x22 mm
39x28 mm

Colour

- Crystal F (001)
- Crystal AB F (001 AB)
- Crystal Golden Shadow F (001 GSHA)
- Crystal Red Magma F (001 REDM)
- Crystal Silver Shade F (001 SSHA)
- Crystal Vitrail Medium (001 VM)
- Jet (280)
- Jet Hematite (280 HEM)
- Jet Metallic Silver (280 METSI)
- Jet Nut (280 NUT)

- Amethyst F (204)
- Aquamarine F (202)
- Black Diamond F (215)
- Burgundy F (515)
- Chrysolite F (238)
- Fuchsia F (502)
- Light Colorado Topaz F (246)
- Light Rose F (223)
- Montana F (207)
- Tanzanite F (539)
- White Opal F (234)

4127/S

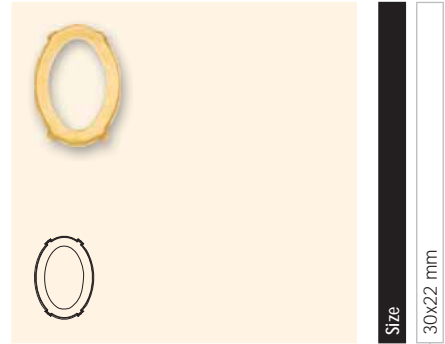

Size
30x22 mm

Ring/Hole, Back Configuration

- 00 C = No ring/hole, closed
- H2 O = 4 holes/2 each side, open



Fancy Stones & Settings

4128 XILION Oval*

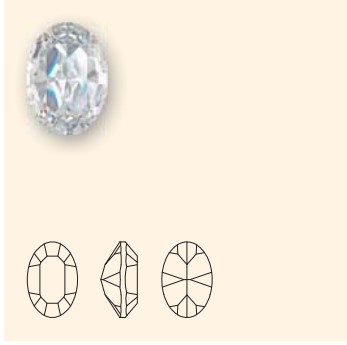

Size
6x4 mm
8x6 mm
10x8 mm
14x10 mm

Colour

Crystal F (001)	■	■	■	■
Crystal AB F (001 AB)	■	■	■	■
Crystal Dorado (001 DOR)	■	■	■	■
Jet (280)	■	■	■	■
Jet Hematite (280 HEM)	■	■	■	■
Jet Metallic Silver (280 METSI)	■	■	■	■
Jet Nut (280 NUT)	■	■	■	■

Air Blue Opal F (285)	■	■	■	■
Amethyst F (204)	■	■	■	■
Aquamarine F (202)	■	■	■	■
Black Diamond F (215)	■	■	■	■
Caribbean Blue Opal F (394)	■	■	■	■
Emerald F (205)	■	■	■	■
Fuchsia F (502)	■	■	■	■
Jonquil F (213)	■	■	■	■
Light Amethyst F (212)	■	■	■	■
Light Grey Opal F (383)	■	■	■	■
Light Rose F (223)	■	■	■	■
Light Sapphire F (211)	■	■	■	■
Light Siam F (227)	■	■	■	■
Montana F (207)	■	■	■	■
Pacific Opal F (390)	■	■	■	■
Palace Green Opal F (393)	■	■	■	■
Peridot F (214)	■	■	■	■
Rose F (209)	■	■	■	■
Rose Water Opal F (395)	■	■	■	■
Sand Opal F (287)	■	■	■	■
Sapphire F (206)	■	■	■	■
Siam F (208)	■	■	■	■
Smoked Topaz F (220)	■	■	■	■
Topaz F (203)	■	■	■	■
White Opal F (234)	■	■	■	■

4128/S



Size
14x10 mm

Ring/Hole, Back Configuration

00 C = No ring/hole, closed	■
H2 O = 4 holes/2 each side, open	■



00 C



H2 O

* Available as of September 2010! Until September 2010 art. 4100 is still available (please refer to former Collection for product details).

Fancy Stones & Settings

4137 Cosmic Oval

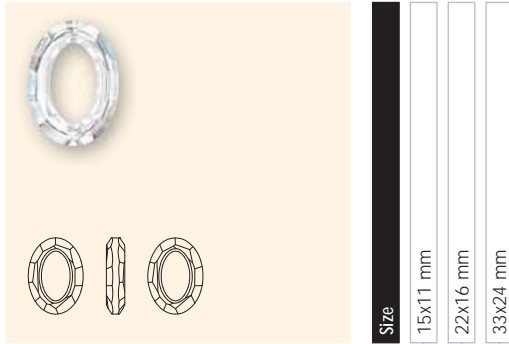

Colour	15x11 mm	22x16 mm	33x24 mm
Crystal (001)	■	■	■
Crystal CAL V SI (001 CAL)	■	■	■
Crystal Bermuda Blue (001 BBL)	■	■	■
Crystal Copper (001 COP)	■	■	■
Crystal Copper CAL V SI (001 COP)	■	■	■
Crystal Dorado (001 DOR)	■	■	■
Crystal Golden Shadow (001 GSHA)	■	■	■
Crystal Golden Shadow CAL V SI (001 GSHA)	■	■	■
Crystal Red Magma (001 REDM)	■	■	■
Crystal Sahara (001 SAH)	■	■	■
Crystal Silver Shade (001 SSHA)	■	■	■
Crystal Silver Shade CAL V SI (001 SSHA)	■	■	■
Crystal Tabac (001 TAB)	■	■	■
Crystal Vitrail Light (001 VL)	■	■	■
Crystal Volcano (001 VOL)	■	■	■
Jet (280)	■	■	■
Jet Hematite (280 HEM)	■	■	■
White Opal (234)	■	■	■

4139 Cosmic Ring

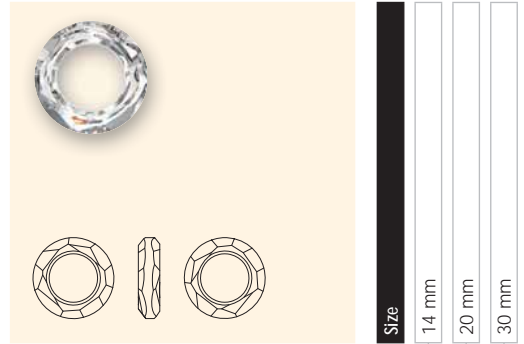

Colour	14 mm	20 mm	30 mm
Crystal (001)	■	■	■
Crystal CAL V SI (001)	■	■	■
Crystal Bermuda Blue (001 BBL)	■	■	■
Crystal Copper (001 COP)	■	■	■
Crystal Copper CAL V SI (001 COP)	■	■	■
Crystal Dorado (001 DOR)	■	■	■
Crystal Golden Shadow (001 GSHA)	■	■	■
Crystal Golden Shadow CAL V SI (001 GSHA)	■	■	■
Crystal Red Magma (001 REDM)	■	■	■
Crystal Sahara (001 SAH)	■	■	■
Crystal Silver Shade (001 SSHA)	■	■	■
Crystal Silver Shade CAL V SI (001 SSHA)	■	■	■
Crystal Tabac (001 TAB)	■	■	■
Crystal Vitrail Light (001 VL)	■	■	■
Crystal Volcano (001 VOL)	■	■	■
Jet (280)	■	■	■
Jet Hematite (280 HEM)	■	■	■
White Opal (234)	■	■	■

Fancy Stones & Settings

Fancy Stones & Settings

4161 Long Classical Oval Fancy Stone

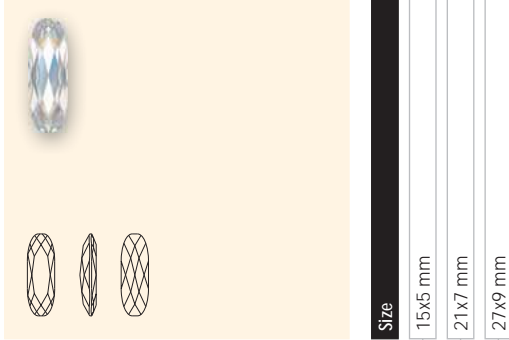

Colour	Size	15x5 mm	21x7 mm	27x9 mm
Crystal F (001)		■	■	■
Amethyst F (204)		■	■	■
Aquamarine F (202)		■	■	■
Indicolite F (379)		■	■	■
Jonquil F (213)		■	■	■
Light Colorado Topaz F (246)		■	■	■
Light Rose F (223)		■	■	■
Olivine F (228)		■	■	■
Padparadscha F (542)		■	■	■

4161/S

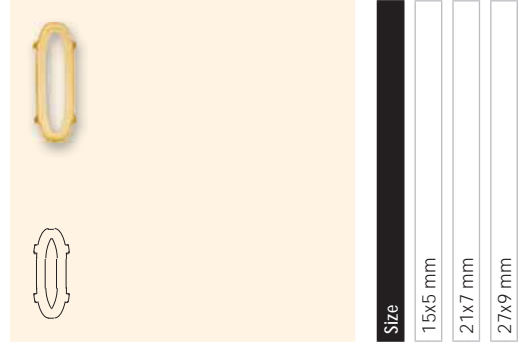

Ring/Hole, Back Configuration	Size	15x5 mm	21x7 mm	27x9 mm
00 C = No ring/hole, closed		■	■	■
H2 O = 4 holes/2 each side, open		■	■	■

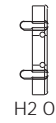

4200

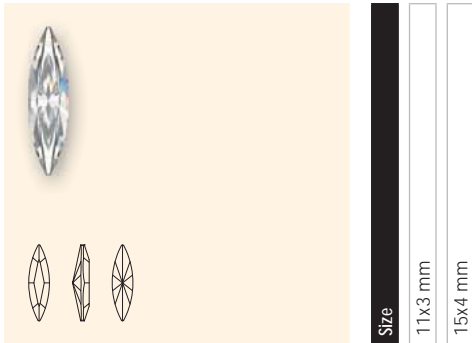

Colour	Size	11x3 mm	15x4 mm
Crystal F (001)		■	■
Crystal AB F (001 AB)	New!	■	■
Crystal Golden Shadow (001 GSHA)	New!	■	■
Crystal Silver Shade (001 SSHA)	New!	■	■
Jet (280)		■	■

Fancy Stones & Settings

4227



Size
32x17 mm

Colour

- Crystal F (001)
- Crystal AB F (001 AB)
- Crystal Golden Shadow F (001 GSHA)
- Crystal Silver Shade F (001 SSHA)
- Jet (280)

4227/S

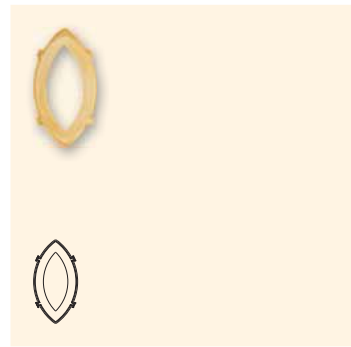

Size
32x17 mm

Ring/Hole, Back Configuration

- 00 C = No ring/hole, closed
- H2 O = 4 holes/2 each side, open

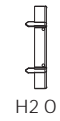
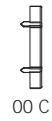

Fancy Stones & Settings

4228



Size 4x2, 5x2.5 mm

4228 XILION Navette

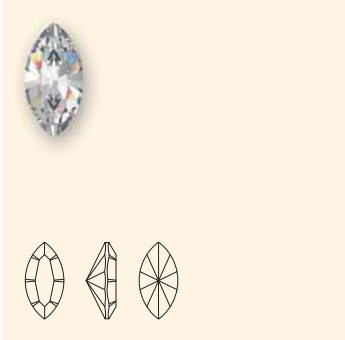









Size 6x3, 8x4, 10x5, 15x7 mm

Fancy Stones & Settings

4228		Size	4x2 mm	5x2.5 mm	6x3 mm	8x4 mm	10x5 mm	15x7 mm
Colour								
	Crystal F (001)		■	■	■	■	■	■
	Crystal AB F (001 AB)		■	■	■	■	■	■
	Crystal Golden Shadow F (001 GSHA)		■	■	■	■	■	■
	Crystal Metallic Light Gold F (001 MLGLD)				■	■	■	■
	Crystal Moonlight F (001 MOL)		■	■	■	■	■	■
	Crystal Silver Shade F (001 SSHA)		■	■	■	■	■	■
	Jet (280)		■	■	■	■	■	■
	Jet Hematite (280 HEM)	New!	■	■	■	■	■	■
	Air Blue Opal F (285)				■	■	■	■
	Amethyst F (204)		■	■	■	■	■	■
	Aquamarine F (202)		■	■	■	■	■	■
	Black Diamond F (215)		■	■	■	■	■	■
	Chrysolite F (238)		■	■	■	■	■	■
	Cyclamen Opal F (398)				■	■	■	■
	Dark Indigo F (288)				■	■	■	■
	Dark Siam F (308)		■					
	Emerald F (205)		■	■	■	■	■	■
	Fern Green F (291)				■	■	■	■
	Fuchsia F (502)		■	■	■	■	■	■
	Indian Pink F (289)				■	■	■	■
	Greige F (284)				■	■	■	■
	Indicolite F (379)		■	■	■	■	■	■
	Jonquil F (213)		■	■	■	■	■	■
	Light Amethyst F (212)		■	■	■	■	■	■
	Light Azore F (361)		■	■	■	■	■	■
	Light Colorado Topaz F (246)		■	■	■	■	■	■
	Light Rose F (223)		■	■	■	■	■	■
	Light Sapphire F (211)		■	■	■	■	■	■
	Light Siam F (227)		■	■	■	■	■	■
	Mocca F (286)		■	■	■	■	■	■
	Montana F (207)		■	■	■	■	■	■
	Olivine F (228)		■	■	■	■	■	■
	Pacific Opal F (390)		■	■	■	■	■	■
	Padparadscha F (542)		■	■	■	■	■	■
	Palace Green Opal F (393)		■	■	■	■	■	■
	Peridot F (214)		■	■	■	■	■	■
	Provence Lavender F (283)				■	■	■	■
	Purple Velvet F (277)		■	■	■	■	■	■
	Rose F (209)		■	■	■	■	■	■

Fancy Stones & Settings

4228		Size	4x2 mm	5x2.5 mm	6x3 mm	8x4 mm	10x5 mm	15x7 mm
Colour								
 Sand Opal F (287)		■		■	■	■	■	■
 Sapphire F (206)		■	■	■	■	■	■	■
 Siam F (208)		■	■	■	■	■	■	■
 Smoked Topaz F (220)		■	■	■	■	■	■	■
 Smoky Quartz F (225)		■		■	■	■	■	■
 Tanzanite F (539)		■		■	■	■	■	■
 Topaz F (203)		■	■	■	■	■	■	■
 White Opal F (234)		■		■	■	■	■	■

Fancy Stones & Settings

4320



Size	6x4 mm	8x6 mm	10x7 mm	14x10 mm	18x13 mm
------	--------	--------	---------	----------	----------

Colour

- Crystal F (001)
- Crystal AB F (001 AB)
- Crystal Copper F (001 COP)
- Crystal Golden Shadow F (001 GSHA)
- Crystal Metallic Light Gold F (001 MLGLD)
- Crystal Moonlight F (001 MOL)
- Crystal Silver Shade F (001 SSHA)
- Jet (280)

- Air Blue Opal F (285)
- Amethyst F (204)
- Aquamarine F (202)
- Black Diamond F (215)
- Caribbean Blue Opal F (394)
- Cyclamen Opal F (398)
- Dark Indigo F (288)
- Emerald F (205)
- Fern Green F (291)
- Greige F (284)
- Khaki F (550)
- Light Colorado Topaz F (246)
- Light Grey Opal F (383)
- Montana F (207)
- Olivine F (228)
- Pacific Opal F (390)
- Padparadscha F (542)
- Palace Green Opal F (393)
- Provence Lavender F (283)
- Purple Velvet F (277)
- Rose F (209)
- Rose Water Opal F (395)
- Siam F (208)
- Tanzanite F (539)
- Topaz F (203)
- Vintage Rose F (319)
- White Opal F (234)

4320/S



Size	18x13 mm
------	----------

Ring/Hole, Back Configuration

- 00 C = No ring/hole, closed
- H2 O = 4 holes/2 each side, open



Fancy Stones & Settings

Fancy Stones & Settings

4327

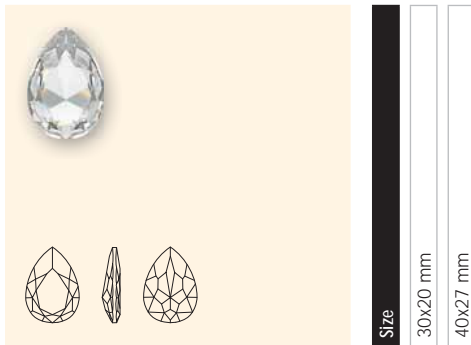

Size
30x20 mm
40x27 mm

Colour

- Crystal F (001)
- Crystal AB F (001 AB)
- Crystal Golden Shadow F (001 GSHA)
- Crystal Red Magma F (001 REDM)
- Crystal Silver Shade F (001 SSHA)
- Crystal Vitrail Medium (001 VM)
- Jet (280)
- Jet Hematite (280 HEM)
- Jet Metallic Silver (280 METSI)
- Jet Nut (280 NUT)

- Amethyst F (204)
- Aquamarine F (202)
- Black Diamond F (215)
- Burgundy F (515)
- Chrysolite F (238)
- Fuchsia F (502)
- Light Colorado Topaz F (246)
- Light Rose F (223)
- Montana F (207)
- Tanzanite F (539)
- White Opal F (234)

4327/S

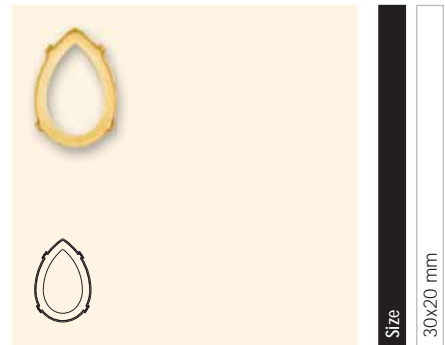

Size
30x20 mm

Ring/Hole, Back Configuration

- 00 C = No ring/hole, closed
- H2 O = 4 holes/2 each side, open



Fancy Stones & Settings

4328 XILION Pear

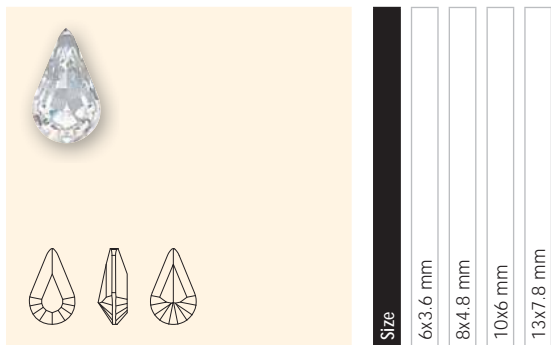

Colour	6x3.6 mm	8x4.8 mm	10x6 mm	13x7.8 mm
Crystal F (001)	■	■	■	■
Crystal AB F (001 AB)	■	■	■	■
Crystal Golden Shadow F (001 GSHA)	■	■	■	■
Crystal Silver Shade F (001 SSHA)	■	■	■	■
Jet (280)	■	■	■	■
Amethyst F (204)	■	■	■	■
Aquamarine F (202)	■	■	■	■
Black Diamond F (215)	■	■	■	■
Emerald F (205)	■	■	■	■
Fern Green F (291)	■	■	■	■
Fuchsia F (502)	■	■	■	■
Khaki F (550)	■	■	■	■
Light Amethyst F (212)	■	■	■	■
Light Colorado Topaz F (246)	■	■	■	■
Light Rose F (223)	■	■	■	■
Light Sapphire F (211)	■	■	■	■
Light Siam F (227)	■	■	■	■
Montana F (207)	■	■	■	■
Peridot F (214)	■	■	■	■
Provence Lavender F (283)	■	■	■	■
Siam F (208)	■	■	■	■
Smoked Topaz F (220)	■	■	■	■
Tanzanite F (539)	■	■	■	■
Topaz F (203)	■	■	■	■
White Opal F (234)	■	■	■	■

4335 Mini Pear Fancy Stone

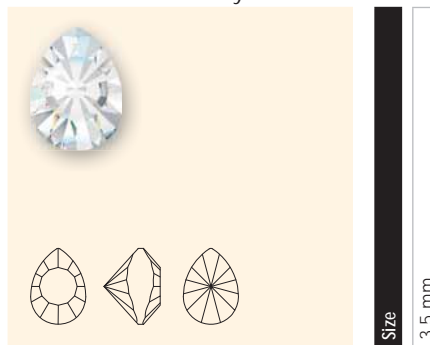

Colour	3.5 mm
Crystal F (001)	■
Aquamarine F (202)	■
Black Diamond F (215)	■
Dark Siam F (308)	■
Indian Siam F (327)	■
Light Amethyst F (212)	■
Light Colorado Topaz F (246)	■
Light Rose F (223)	■
Peridot F (214)	■

Fancy Stones & Settings

4370



Colour

- Crystal (001)
- Crystal F (001)
- Crystal Golden Shadow (001 GSHA) New!
- Tanzanite (539)

Size	11x10 mm	15.5x14 mm	20x18 mm
<input type="checkbox"/>	<input type="checkbox"/>	<input type="checkbox"/>	<input type="checkbox"/>

Fancy Stones & Settings

4428

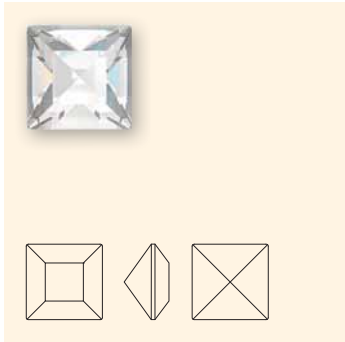

Size 2 mm

4428 XILION Square

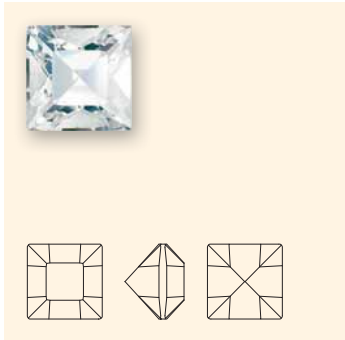

Size 3, 4 mm

4428 XILION Square

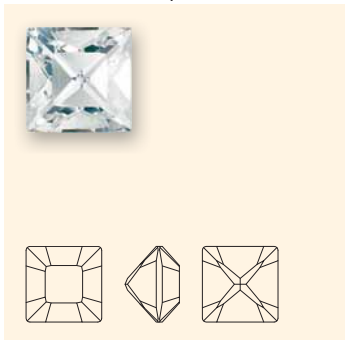

Size 5, 6, 8 mm

4428		Size	2 mm	3 mm	4 mm	5 mm	6 mm	8 mm
Colour								
	Crystal F (001)		■	■	■	■	■	■
	Crystal AB F (001 AB)		■	■	■	■	■	■
	Crystal Golden Shadow F (001 GSHA)		■	■	■	■	■	■
	Crystal Metallic Light Gold F (001 MLGLD)		■	■	■	■	■	■
	Crystal Silver Shade F (001 SSHA)		■	■	■	■	■	■
	Jet (280)		■	■	■	■	■	■
	Jet Hematite (280 HEM)	New!	■	■	■	■	■	■
	Air Blue Opal F (285)		■	■	■	■	■	■
	Amethyst F (204)		■	■	■	■	■	■
	Aquamarine F (202)		■	■	■	■	■	■
	Black Diamond F (215)		■	■	■	■	■	■
	Burgundy F (515)		■	■	■	■	■	■
	Cyclamen Opal F (398)		■	■	■	■	■	■
	Dark Indigo F (288)		■	■	■	■	■	■
	Dark Siam F (308)		■	■	■	■	■	■
	Emerald F (205)		■	■	■	■	■	■
	Fern Green F (291)		■	■	■	■	■	■
	Fuchsia F (502)		■	■	■	■	■	■
	Greige F (284)		■	■	■	■	■	■
	Indicolite F (379)		■	■	■	■	■	■
	Jonquil F (213)		■	■	■	■	■	■
	Light Amethyst F (212)		■	■	■	■	■	■
	Light Colorado Topaz F (246)		■	■	■	■	■	■
	Light Peach F (362)		■	■	■	■	■	■
	Light Rose F (223)		■	■	■	■	■	■
	Light Sapphire F (211)		■	■	■	■	■	■
	Light Siam F (227)		■	■	■	■	■	■
	Light Smoked Topaz F (221)		■	■	■	■	■	■
	Montana F (207)		■	■	■	■	■	■
	Pacific Opal F (390)		■	■	■	■	■	■
	Peridot F (214)		■	■	■	■	■	■
	Provence Lavender F (283)		■	■	■	■	■	■
	Rose F (209)		■	■	■	■	■	■
	Sapphire F (206)		■	■	■	■	■	■
	Siam F (208)		■	■	■	■	■	■
	Smoked Topaz F (220)		■	■	■	■	■	■
	Smoky Quartz F (225)		■	■	■	■	■	■
	Tanzanite F (539)		■	■	■	■	■	■
	Topaz F (203)		■	■	■	■	■	■

Fancy Stones & Settings

4428



Size

- 2 mm
- 3 mm
- 4 mm
- 5 mm
- 6 mm
- 8 mm

Colour

- Violet F (371)
- White Opal F (234)

4428/S

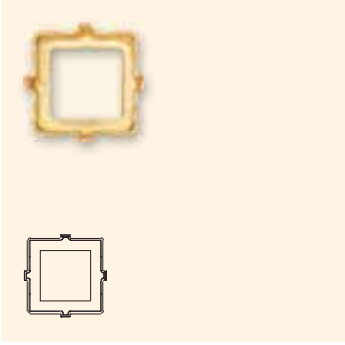

Size

- 6 mm
- 8 mm

Ring/Hole, Back Configuration

- 00 C = No ring/hole, closed
- H2 0 = 4 holes/2 each side, open



Fancy Stones & Settings

4437 Cosmic Square Ring



Size	14 mm	20 mm	30 mm
------	-------	-------	-------

Colour

Crystal (001)	■	■	■
Crystal CAL V SI (001 CAL)	■	■	■
Crystal Bermuda Blue (001 BBL)	■	■	
Crystal Copper (001 COP)	■	■	
Crystal Copper CAL V SI (001 COP)	■	■	
Crystal Dorado (001 DOR)	■	■	
Crystal Golden Shadow (001 GSHA)	■	■	■
Crystal Golden Shadow CAL V SI (001 GSHA)	■	■	
Crystal Red Magma (001 REDM)	■	■	
Crystal Sahara (001 SAH)	■	■	
Crystal Silver Shade (001 SSHA)	■	■	■
Crystal Silver Shade CAL V SI (001 SSHA)	■	■	
Crystal Tabac (001 TAB)	■	■	
Crystal Vitrail Light (001 VL)	■	■	
Crystal Volcano (001 VOL)	■	■	
Jet (280)	■	■	■
White Opal (234)	■	■	■

New!

4439 Square Ring

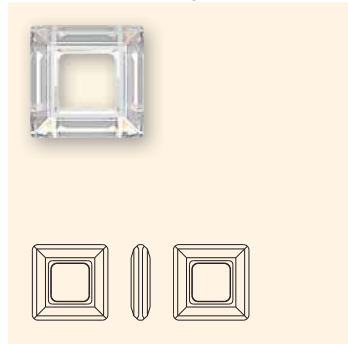

Size	14 mm	20 mm	30 mm
------	-------	-------	-------

Colour

Crystal (001)	■	■	■
Crystal CAL V SI (001)	■	■	■
Crystal Bermuda Blue (001 BBL)	■	■	
Crystal Copper (001 COP)	■	■	
Crystal Copper CAL V SI (001 COP)	■	■	
Crystal Dorado (001 DOR)	■	■	
Crystal Golden Shadow (001 GSHA)	■	■	■
Crystal Golden Shadow CAL V SI (001 GSHA)	■	■	
Crystal Red Magma (001 REDM)	■	■	
Crystal Sahara (001 SAH)	■	■	
Crystal Silver Shade (001 SSHA)	■	■	■
Crystal Silver Shade CAL V SI (001 SSHA)	■	■	
Crystal Tabac (001 TAB)	■	■	
Crystal Vitrail Light (001 VL)	■	■	
Crystal Volcano (001 VOL)	■	■	
Jet (280)	■	■	■
Jet Hematite (280 HEM)	■	■	■
White Opal (234)	■	■	■

New!

New!

Fancy Stones & Settings

Fancy Stones & Settings

4447 Princess Square Fancy Stone



Colour	6 mm	8 mm	10 mm	12 mm
Crystal F (001)	■	■	■	■
Crystal Golden Shadow F (001 GSHA)	■	■	■	■
Crystal Silver Shade F (001 SSHA)	■	■	■	■
Aquamarine F (202)				■
Light Amethyst F (212)				■
Light Rose F (223)				■
Light Sapphire F (211)				■
Light Siam F (227)				■
Light Smoked Topaz F (221)				■
Tanzanite F (539)				■
White Opal F (234)				■

4447/S

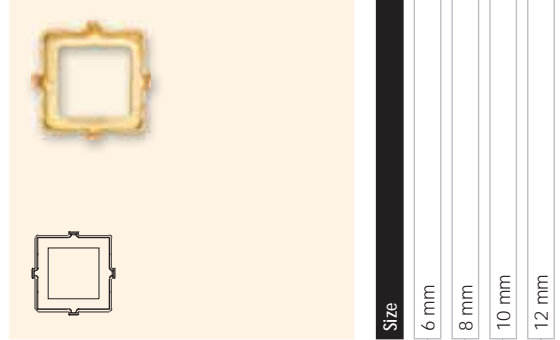

Ring/Hole, Back Configuration	6 mm	8 mm	10 mm	12 mm
00 C = No ring/hole, closed	■	■	■	■
H2 O = 4 holes/2 each side, open	■	■	■	■

00 C	
H2 O	

4461 Classical Square Fancy Stone

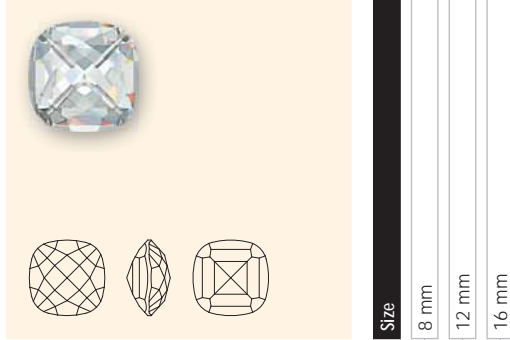

Colour	8 mm	12 mm	16 mm
Crystal F (001)	■	■	■
Crystal Golden Shadow F (001 GSHA)	■	■	■
Crystal Silver Shade F (001 SSHA)	■	■	■
Crystal Satin F (001 SAT)	■	■	■

4461/S

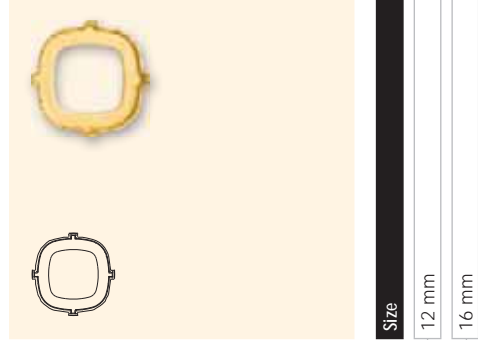

Ring/Hole, Back Configuration	12 mm	16 mm
00 C = No ring/hole, closed	■	■
H2 O = 4 holes/2 each side, open	■	■

00 C	
H2 O	

Fancy Stones & Settings

4470



Size	10 mm	12 mm	18 mm
------	-------	-------	-------

Colour

<input type="checkbox"/> Crystal (001) <small>New!</small>	<input type="checkbox"/>	<input type="checkbox"/>	<input type="checkbox"/>
<input type="checkbox"/> Crystal F (001)	<input type="checkbox"/>	<input type="checkbox"/>	<input type="checkbox"/>
<input type="checkbox"/> Crystal Copper F (001 COP)	<input type="checkbox"/>	<input type="checkbox"/>	<input type="checkbox"/>
<input type="checkbox"/> Crystal Golden Shadow (001 GSHA)	<input type="checkbox"/>	<input type="checkbox"/>	<input type="checkbox"/>
<input type="checkbox"/> Crystal Golden Shadow F (001 GSHA)	<input type="checkbox"/>	<input type="checkbox"/>	<input type="checkbox"/>
<input type="checkbox"/> Crystal Metallic Light Gold F (001 MLGLD)	<input type="checkbox"/>	<input type="checkbox"/>	<input type="checkbox"/>
<input type="checkbox"/> Crystal Moonlight F (001 MOL)	<input type="checkbox"/>	<input type="checkbox"/>	<input type="checkbox"/>
<input type="checkbox"/> Crystal Silver Shade (001 SSHA)	<input type="checkbox"/>	<input type="checkbox"/>	<input type="checkbox"/>
<input type="checkbox"/> Crystal Silver Shade F (001 SSHA)	<input type="checkbox"/>	<input type="checkbox"/>	<input type="checkbox"/>
<input type="checkbox"/> Jet (280)	<input type="checkbox"/>	<input type="checkbox"/>	<input type="checkbox"/>
<input type="checkbox"/> Air Blue Opal F (285)	<input type="checkbox"/>	<input type="checkbox"/>	<input type="checkbox"/>
<input type="checkbox"/> Aquamarine F (202)	<input type="checkbox"/>	<input type="checkbox"/>	<input type="checkbox"/>
<input type="checkbox"/> Black Diamond F (215)	<input type="checkbox"/>	<input type="checkbox"/>	<input type="checkbox"/>
<input type="checkbox"/> Burgundy F (515)	<input type="checkbox"/>	<input type="checkbox"/>	<input type="checkbox"/>
<input type="checkbox"/> Caribbean Blue Opal F (394)	<input type="checkbox"/>	<input type="checkbox"/>	<input type="checkbox"/>
<input type="checkbox"/> Chrysolite F (238)	<input type="checkbox"/>	<input type="checkbox"/>	<input type="checkbox"/>
<input type="checkbox"/> Cyclamen Opal (398)	<input type="checkbox"/>	<input type="checkbox"/>	<input type="checkbox"/>
<input type="checkbox"/> Cyclamen Opal F (398)	<input type="checkbox"/>	<input type="checkbox"/>	<input type="checkbox"/>
<input type="checkbox"/> Dark Indigo F (288)	<input type="checkbox"/>	<input type="checkbox"/>	<input type="checkbox"/>
<input type="checkbox"/> Erinite F (360)	<input type="checkbox"/>	<input type="checkbox"/>	<input type="checkbox"/>
<input type="checkbox"/> Fern Green (291)	<input type="checkbox"/>	<input type="checkbox"/>	<input type="checkbox"/>
<input type="checkbox"/> Fern Green F (291)	<input type="checkbox"/>	<input type="checkbox"/>	<input type="checkbox"/>
<input type="checkbox"/> Greige (284)	<input type="checkbox"/>	<input type="checkbox"/>	<input type="checkbox"/>
<input type="checkbox"/> Greige F (284)	<input type="checkbox"/>	<input type="checkbox"/>	<input type="checkbox"/>
<input type="checkbox"/> Indian Pink F (289)	<input type="checkbox"/>	<input type="checkbox"/>	<input type="checkbox"/>
<input type="checkbox"/> Indicolite F (379)	<input type="checkbox"/>	<input type="checkbox"/>	<input type="checkbox"/>
<input type="checkbox"/> Khaki F (550)	<input type="checkbox"/>	<input type="checkbox"/>	<input type="checkbox"/>
<input type="checkbox"/> Light Azore F (361)	<input type="checkbox"/>	<input type="checkbox"/>	<input type="checkbox"/>
<input type="checkbox"/> Light Colorado Topaz F (246)	<input type="checkbox"/>	<input type="checkbox"/>	<input type="checkbox"/>
<input type="checkbox"/> Light Grey Opal F (383)	<input type="checkbox"/>	<input type="checkbox"/>	<input type="checkbox"/>
<input type="checkbox"/> Light Peach F (362)	<input type="checkbox"/>	<input type="checkbox"/>	<input type="checkbox"/>
<input type="checkbox"/> Light Smoked Topaz F (221)	<input type="checkbox"/>	<input type="checkbox"/>	<input type="checkbox"/>
<input type="checkbox"/> Light Topaz F (226)	<input type="checkbox"/>	<input type="checkbox"/>	<input type="checkbox"/>
<input type="checkbox"/> Mocca F (286)	<input type="checkbox"/>	<input type="checkbox"/>	<input type="checkbox"/>
<input type="checkbox"/> Pacific Opal F (390)	<input type="checkbox"/>	<input type="checkbox"/>	<input type="checkbox"/>
<input type="checkbox"/> Padparadscha F (542)	<input type="checkbox"/>	<input type="checkbox"/>	<input type="checkbox"/>
<input type="checkbox"/> Palace Green Opal F (393)	<input type="checkbox"/>	<input type="checkbox"/>	<input type="checkbox"/>
<input type="checkbox"/> Purple Velvet F (277)	<input type="checkbox"/>	<input type="checkbox"/>	<input type="checkbox"/>
<input type="checkbox"/> Provence Lavender (283)	<input type="checkbox"/>	<input type="checkbox"/>	<input type="checkbox"/>

4470



Size	10 mm	12 mm	18 mm
------	-------	-------	-------

Colour

<input type="checkbox"/> Provence Lavender F (283)	<input type="checkbox"/>	<input type="checkbox"/>	<input type="checkbox"/>
<input type="checkbox"/> Rose Water Opal F (395)	<input type="checkbox"/>	<input type="checkbox"/>	<input type="checkbox"/>
<input type="checkbox"/> Sand Opal F (287)	<input type="checkbox"/>	<input type="checkbox"/>	<input type="checkbox"/>
<input type="checkbox"/> Siam F (208)	<input type="checkbox"/>	<input type="checkbox"/>	<input type="checkbox"/>
<input type="checkbox"/> Smoked Topaz F (220)	<input type="checkbox"/>	<input type="checkbox"/>	<input type="checkbox"/>
<input type="checkbox"/> Smoky Quartz F (225)	<input type="checkbox"/>	<input type="checkbox"/>	<input type="checkbox"/>
<input type="checkbox"/> Tanzanite F (539)	<input type="checkbox"/>	<input type="checkbox"/>	<input type="checkbox"/>
<input type="checkbox"/> Vintage Rose F (319)	<input type="checkbox"/>	<input type="checkbox"/>	<input type="checkbox"/>
<input type="checkbox"/> Violet F (371)	<input type="checkbox"/>	<input type="checkbox"/>	<input type="checkbox"/>
<input type="checkbox"/> White Opal F (234)	<input type="checkbox"/>	<input type="checkbox"/>	<input type="checkbox"/>

4470/S

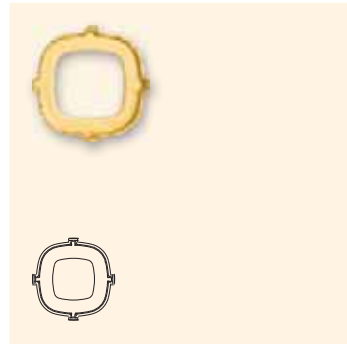

Size	10 mm	12 mm
------	-------	-------

Ring/Hole, Back Configuration

<input type="checkbox"/> 00 C = No ring/hole, closed	<input type="checkbox"/>	<input type="checkbox"/>
<input type="checkbox"/> H2 O = 4 holes/2 each side, open	<input type="checkbox"/>	<input type="checkbox"/>



Fancy Stones & Settings

4500

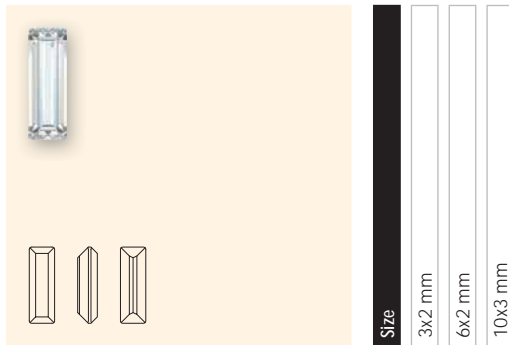

Colour	3x2 mm	6x2 mm	10x3 mm
Crystal F (001)	■	■	■
Jet (280)	■	■	■
Amethyst F (204)	■		
Aquamarine F (202)	■		
Black Diamond F (215)	■		
Emerald F (205)	■		
Jonquil F (213)	■		
Light Amethyst F (212)	■		
Light Rose F (223)	■		
Light Sapphire F (211)	■		
Light Siam F (227)	■		
Light Smoked Topaz F (221)	■		
Montana F (207)	■		
Peridot F (214)	■		
Rose F (209)	■		
Sapphire F (206)	■		
Siam F (208)	■		
Smoked Topaz F (220)	■		
Topaz F (203)	■		



Fancy Stones & Settings

4501

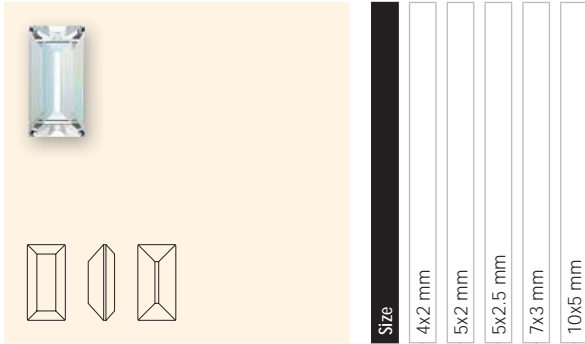

Colour	Size	4x2 mm	5x2 mm	5x2.5 mm	7x3 mm	10x5 mm
Crystal (001)		■	■	■	■	■
Crystal F (001)		■	■	■	■	■
Crystal AB F (001 AB)		■	■	■	■	■
Crystal Golden Shadow F (001 GSHA)		■	■	■	■	■
Jet (280)		■	■	■	■	■
Jet Hermitite (280 HEM)	Neu!	■	■	■	■	■
Amethyst F (204)		■	■	■	■	■
Aquamarine F (202)		■	■	■	■	■
Black Diamond F (215)		■	■	■	■	■
Dark Siam F (308)		■	■	■	■	■
Emerald F (205)		■	■	■	■	■
Erinite F (360)		■	■	■	■	■
Fuchsia F (502)		■	■	■	■	■
Jonquil F (213)		■	■	■	■	■
Light Amethyst F (212)		■	■	■	■	■
Light Peach F (362)		■	■	■	■	■
Light Rose F (223)		■	■	■	■	■
Light Sapphire F (211)		■	■	■	■	■
Light Siam F (227)		■	■	■	■	■
Light Smoked Topaz F (221)		■	■	■	■	■
Light Topaz F (226)		■	■	■	■	■
Montana F (207)		■	■	■	■	■
Padparadscha F (542)		■	■	■	■	■
Peridot F (214)		■	■	■	■	■
Rose F (209)		■	■	■	■	■
Sapphire F (206)		■	■	■	■	■
Siam F (208)		■	■	■	■	■
Smoked Topaz F (220)		■	■	■	■	■
Smoky Quartz F (225)		■	■	■	■	■
Tanzanite F (539)		■	■	■	■	■
Topaz F (203)		■	■	■	■	■
Violet F (371)		■	■	■	■	■
White Opal F (234)		■	■	■	■	■

4501/S

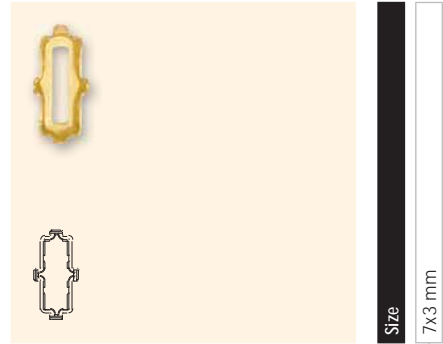

Ring/Hole, Back Configuration	Size
00 C = No ring/hole, closed	7x3 mm
H2 O = 4 holes/2 each side, open	7x3 mm

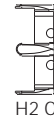
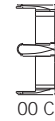

Fancy Stones & Settings

Fancy Stones & Settings

4502

Size
3x1 mm

Colour
Crystal F (001)

4527 Step Cut Fancy Stone

Size
8x6 mm
14x10 mm
18x13 mm

Colour

- Crystal F (001)
- Crystal Golden Shadow F (001 GSHA)
- Crystal Silver Shade F (001 SSHA)
- Erinite F (360)
- Light Amethyst F (212)
- Light Azore F (361)
- Montana F (207)
- Smoky Quartz F (225)
- Tanzanite F (539)

4527/S

Size
8x6 mm
14x10 mm

Ring/Hole, Back Configuration

- 00 C = No ring/hole, closed
- H2 O = 4 holes/2 each side, open

00 C H2 O

Fancy Stones & Settings

4547 Princess Baguette Fancy Stone

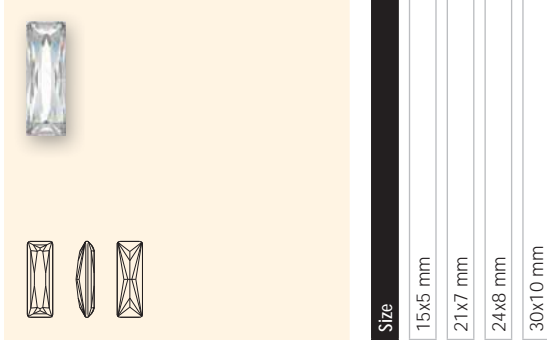

Colour	Size	15x5 mm	21x7 mm	24x8 mm	30x10 mm
Crystal F (001)		■	■	■	■
Crystal Copper F (001 COP)		■	■	■	■
Crystal Red Magma F (001 REDM)	<i>New!</i>	■	■	■	■
Crystal Golden Shadow F (001 GSHA)		■	■	■	■
Crystal Silver Shade F (001 SSHA)		■	■	■	■
Jet (280)		■	■	■	■
Aquamarine F (202)		■	■	■	■
Black Diamond F (215)		■	■	■	■
Burgundy F (515)		■	■	■	■
Erinite F (360)		■	■	■	■
Light Rose F (223)		■	■	■	■
Light Smoked Topaz F (221)		■	■	■	■
Padparadscha F (542)		■	■	■	■
Tanzanite F (539)		■	■	■	■

4547/S

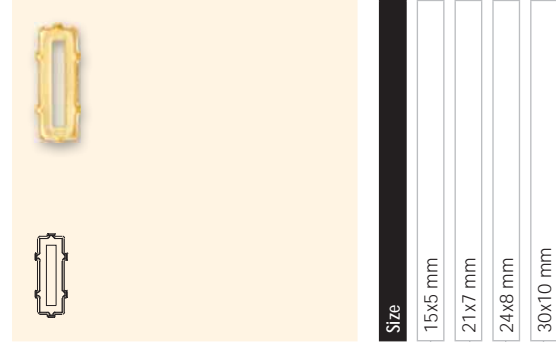

Ring/Hole, Back Configuration	Size	15x5 mm	21x7 mm	24x8 mm	30x10 mm
00 C = No ring/hole, closed		■	■	■	■
H2 O = 4 holes/2 each side, open		■	■	■	■

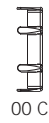

Fancy Stones & Settings

4565 Classical Baguette Fancy Stone



Size
14x10 mm
18x13 mm

Colour

<input type="checkbox"/>	Crystal (001)	<input type="checkbox"/>	<input type="checkbox"/>
<input type="checkbox"/>	Crystal F (001)	<input type="checkbox"/>	<input type="checkbox"/>
<input type="checkbox"/>	Crystal Golden Shadow F (001 GSHA)	<input type="checkbox"/>	<input type="checkbox"/>
<input type="checkbox"/>	Crystal Silver Shade F (001 SSHA) <small>New!</small>	<input type="checkbox"/>	<input type="checkbox"/>
<input type="checkbox"/>	Jet (280)	<input type="checkbox"/>	<input type="checkbox"/>
<input type="checkbox"/>	Aquamarine (202)	<input type="checkbox"/>	<input type="checkbox"/>
<input type="checkbox"/>	Aquamarine F (202)	<input type="checkbox"/>	<input type="checkbox"/>
<input type="checkbox"/>	Light Rose (223)	<input type="checkbox"/>	<input type="checkbox"/>
<input type="checkbox"/>	Light Rose F (223)	<input type="checkbox"/>	<input type="checkbox"/>
<input type="checkbox"/>	Tanzanite (539)	<input type="checkbox"/>	<input type="checkbox"/>
<input type="checkbox"/>	Tanzanite F (539)	<input type="checkbox"/>	<input type="checkbox"/>

4581 Stage Flat Fancy Stone

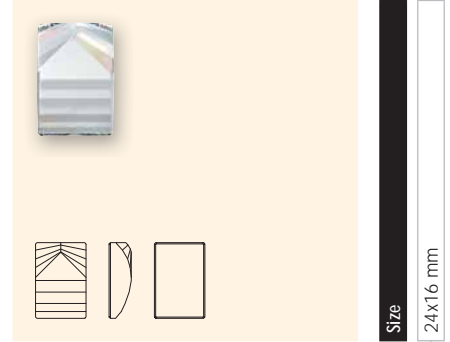

Size
24x16 mm

Colour

<input type="checkbox"/>	Crystal CAL V SI (001)	<input type="checkbox"/>	<input type="checkbox"/>
<input type="checkbox"/>	Crystal AB CAL V SI (001 AB)	<input type="checkbox"/>	<input type="checkbox"/>
<input type="checkbox"/>	Crystal Copper CAL V SI (001 COP)	<input type="checkbox"/>	<input type="checkbox"/>
<input type="checkbox"/>	Crystal Golden Shadow CAL V SI (001 GSHA) <small>New!</small>	<input type="checkbox"/>	<input type="checkbox"/>
<input type="checkbox"/>	Crystal Silver Shade CAL V SI (001 SSHA)	<input type="checkbox"/>	<input type="checkbox"/>
<input type="checkbox"/>	Crystal Satin CAL V SI (001 SAT)	<input type="checkbox"/>	<input type="checkbox"/>
<input type="checkbox"/>	Jet (280)	<input type="checkbox"/>	<input type="checkbox"/>
<input type="checkbox"/>	Jet Hematite (280 HEM)	<input type="checkbox"/>	<input type="checkbox"/>
<input type="checkbox"/>	Jet Metallic Silver (280 METSI)	<input type="checkbox"/>	<input type="checkbox"/>
<input type="checkbox"/>	Jet Nut (280 NUT)	<input type="checkbox"/>	<input type="checkbox"/>

4582 Step Cut Flat Fancy Stone

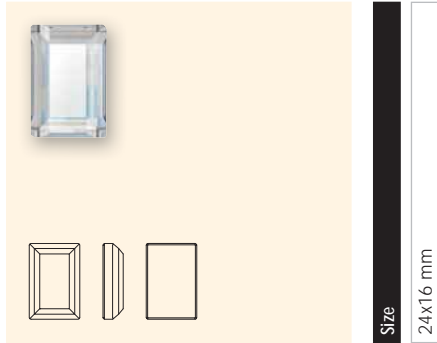

Size
24x16 mm

Colour

<input type="checkbox"/>	Crystal CAL V SI (001)	<input type="checkbox"/>	<input type="checkbox"/>
<input type="checkbox"/>	Crystal AB CAL V SI (001 AB)	<input type="checkbox"/>	<input type="checkbox"/>
<input type="checkbox"/>	Crystal Copper CAL V SI (001 COP)	<input type="checkbox"/>	<input type="checkbox"/>
<input type="checkbox"/>	Crystal Golden Shadow CAL V SI (001 GSHA)	<input type="checkbox"/>	<input type="checkbox"/>
<input type="checkbox"/>	Crystal Silver Shade CAL V SI (001 SSHA) <small>New!</small>	<input type="checkbox"/>	<input type="checkbox"/>
<input type="checkbox"/>	Crystal Satin CAL V SI (001 SAT)	<input type="checkbox"/>	<input type="checkbox"/>
<input type="checkbox"/>	Jet (280)	<input type="checkbox"/>	<input type="checkbox"/>
<input type="checkbox"/>	Jet Hematite (280 HEM)	<input type="checkbox"/>	<input type="checkbox"/>
<input type="checkbox"/>	Jet Metallic Silver (280 METSI)	<input type="checkbox"/>	<input type="checkbox"/>
<input type="checkbox"/>	Jet Nut (280 NUT)	<input type="checkbox"/>	<input type="checkbox"/>

4583 Graphic Flat Fancy Stone

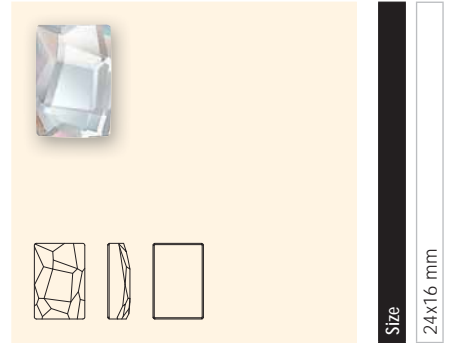

Size
24x16 mm

Colour

<input type="checkbox"/>	Crystal CAL V SI (001)	<input type="checkbox"/>	<input type="checkbox"/>
<input type="checkbox"/>	Crystal AB CAL V SI (001 AB)	<input type="checkbox"/>	<input type="checkbox"/>
<input type="checkbox"/>	Crystal Copper CAL V SI (001 COP)	<input type="checkbox"/>	<input type="checkbox"/>
<input type="checkbox"/>	Crystal Golden Shadow CAL V SI (001 GSHA)	<input type="checkbox"/>	<input type="checkbox"/>
<input type="checkbox"/>	Crystal Silver Shade CAL V SI (001 SSHA) <small>New!</small>	<input type="checkbox"/>	<input type="checkbox"/>
<input type="checkbox"/>	Crystal Satin CAL V SI (001 SAT)	<input type="checkbox"/>	<input type="checkbox"/>
<input type="checkbox"/>	Jet (280)	<input type="checkbox"/>	<input type="checkbox"/>
<input type="checkbox"/>	Jet Hematite (280 HEM)	<input type="checkbox"/>	<input type="checkbox"/>
<input type="checkbox"/>	Jet Metallic Silver (280 METSI)	<input type="checkbox"/>	<input type="checkbox"/>
<input type="checkbox"/>	Jet Nut (280 NUT)	<input type="checkbox"/>	<input type="checkbox"/>

Fancy Stones & Settings

4584 Chessboard Flat Fancy Stone

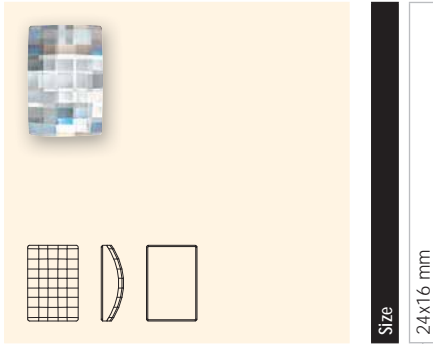

Size
24x16 mm

Colour	
	Crystal CAL V SI (001)
	Crystal AB CAL V SI (001 AB)
	Crystal Copper CAL V SI (001 COP)
	Crystal Golden Shadow CAL V SI (001 GSHA)
	Crystal Silver Shade CAL V SI (001 SSHA) <i>New!</i>
	Crystal Satin CAL V SI (001 SAT)
	Jet (280)
	Jet Hematite (280 HEM)
	Jet Metallic Silver (280 METSI)
	Jet Nut (280 NUT)

4600

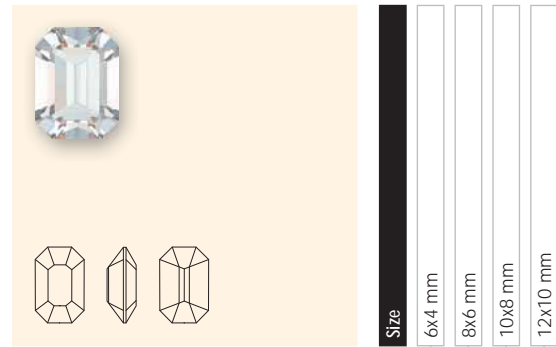

Size
6x4 mm
8x6 mm
10x8 mm
12x10 mm

Colour	
	Crystal F (001)
	Crystal AB F (001 AB) <i>New!</i>
	Crystal Golden Shadow F (001 GSHA) <i>New!</i>
	Crystal Silver Shade F (001 SSHA) <i>New!</i>
	Jet (280)
	Aquamarine F (202)
	Montana F (207)
	Rose F (209)
	Siam F (208)
	Topaz F (203)

Fancy Stones & Settings

Fancy Stones & Settings

4610

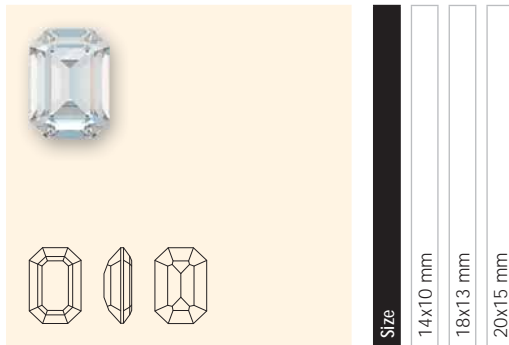

Colour		Size		
		14x10 mm	18x13 mm	20x15 mm
Crystal F (001)	<i>New!</i>	■	■	■
Crystal Golden Shadow F (001 GSHA)		■	■	■
Crystal Silver Shade F (001 SSHA)		■	■	■
Jet (280)		■	■	■
Amethyst F (204)		■	■	
Aquamarine F (202)		■	■	
Black Diamond F (215)		■	■	
Emerald F (205)		■	■	
Indian Sapphire F (217)		■	■	
Light Colorado Topaz F (246)		■	■	
Light Rose F (223)		■	■	
Montana F (207)		■	■	
Peridot F (214)		■	■	
Rose F (209)		■	■	
Siam F (208)		■	■	
Tanzanite F (539)		■	■	
Topaz F (203)		■	■	

4610/S

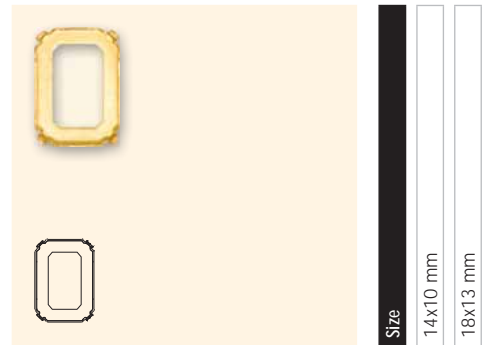

Ring/Hole, Back Configuration		Size	
		14x10 mm	18x13 mm
00 C = No ring/hole, closed		■	■
H2 O = 4 holes/2 each side, open		■	■



Fancy Stones & Settings

4627

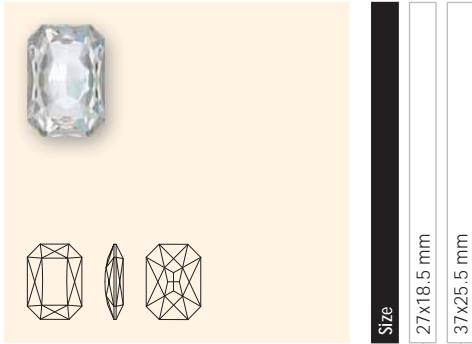

Size

27x18.5 mm

37x25.5 mm

Colour

- Crystal F (001)
- Crystal AB F (001 AB)
- Crystal Golden Shadow F (001 GSHA)
- Crystal Moonlight F (001 MOL)
- Crystal Red Magma F (001 REDM)
- Crystal Silver Shade F (001 SSHA)
- Crystal Vitrail Medium (001 VM)
- Jet (280)
- Jet Hematite (280 HEM)
- Jet Metallic Silver (280 METSI)
- Jet Nut (280 NUT)

- Amethyst F (204)
- Aquamarine F (202)
- Black Diamond F (215)
- Burgundy F (515)
- Chrysolite F (238)
- Emerald F (205)
- Fuchsia F (502)
- Light Colorado Topaz F (246)
- Light Rose F (223)
- Montana F (207)
- Tanzanite F (539)
- White Opal F (234)

4627/S

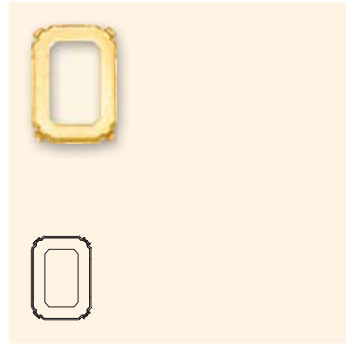

Size

27x18.5 mm

Ring/Hole, Back Configuration

- 00 C = No ring/hole, closed
- H2 O = 4 holes/2 each side, open



Fancy Stones & Settings

Fancy Stones & Settings

4675

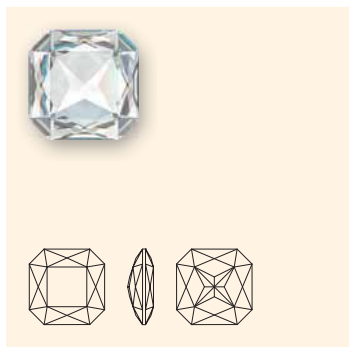

Size 23 mm

- Colour**
- Crystal F (001)
 - Crystal AB F (001 AB)
 - Crystal Golden Shadow F (001 GSHA)
 - Crystal Red Magma F (001 REDM)
 - Crystal Sahara F (280)
 - Crystal Silver Shade F (001 SSHA)
 - Crystal Vitrail Medium (001 VM)
 - Jet (280)

4704 Mini Triangle Fancy Stone

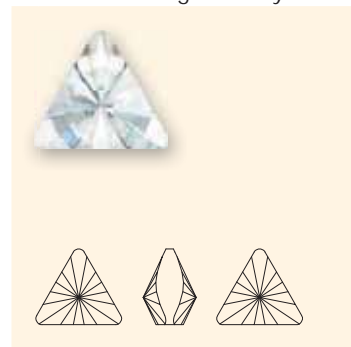

Size 5 mm

- Colour**
- Crystal F (001)
 - Jet (280)
 - Aquamarine F (202)
 - Black Diamond F (215)
 - Light Amethyst F (212)
 - Light Colorado Topaz F (246)
 - Light Rose F (223)
 - Peridot F (214)

4722



Size 4 mm 6 mm 8 mm 10 mm

- Colour**
- Crystal F (001)
 - Crystal Golden Shadow F (001 GSHA)
 - Crystal Silver Shade F (001 SSHA)

Fancy Stones & Settings

Fancy Stones & Settings

4727

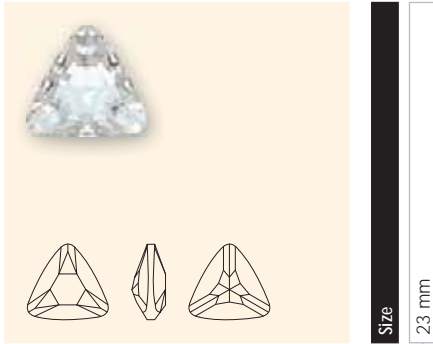

- Colour**
- Crystal F (001)
 - Crystal Golden Shadow F (001 GSHA)
 - Crystal Silver Shade F (001 SSHA)

Size
23 mm

4727/S

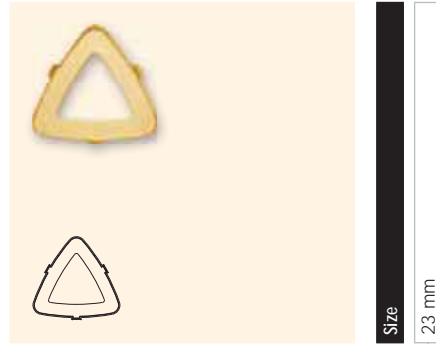

- Ring/Hole, Back Configuration**
- 00 C = No ring/hole, closed
 - H2 O = 4 holes/2 each side, open

Size
23 mm

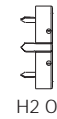

4735 Mini Blossom Fancy Stone

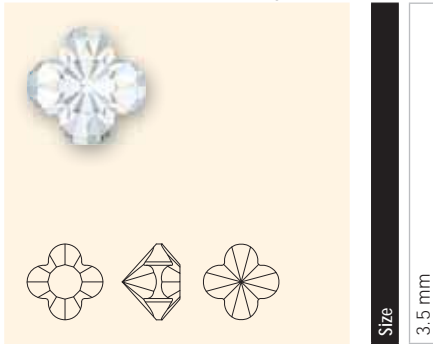

- Colour**
- Crystal F (001)
 - Aquamarine F (202)
 - Black Diamond F (215)
 - Dark Siam F (308) *New!*
 - Indian Siam F (327) *New!*
 - Light Amethyst F (212)
 - Light Colorado Topaz F (246)
 - Light Rose F (223)
 - Peridot F (214)

Size
3.5 mm

4737 Cosmic Triangle



- Colour**
- Crystal (001)
 - Crystal CAL V SI (001)
 - Crystal Bermuda Blue (001 BBL)
 - Crystal Copper (001 COP)
 - Crystal Copper CAL V SI (001 COP)
 - Crystal Dorado (001 DOR)
 - Crystal Golden Shadow (001 GSHA)
 - Crystal Golden Shadow CAL V SI (001 GSHA)
 - Crystal Red Magma (001 REDM)
 - Crystal Sahara (001 SAH)
 - Crystal Silver Shade (001 SSHA)
 - Crystal Silver Shade CAL V SI (001 SSHA)
 - Crystal Tabac (001 TAB)
 - Crystal Vitrail Light (001 VL)
 - Crystal Volcano (001 VOL)
 - Jet (280)
 - Jet Hematite (280 HEM) *New!*
 - White Opal (234) *New!*

Size
14 mm
20 mm
30 mm

Fancy Stones & Settings

Fancy Stones & Settings

4739 Cosmic Fancy Stone



Size
14x11 mm
20x16 mm

Colour	
<input type="checkbox"/>	Crystal F (001)
<input type="checkbox"/>	Crystal Golden Shadow F (001 GSHA)
<input type="checkbox"/>	Crystal Red Magma F (001 REDM)
<input type="checkbox"/>	Crystal Silver Shade F (001 SSHA)
<input type="checkbox"/>	Jet (280)
<input type="checkbox"/>	Jet Hematite (280 HEM)
<input type="checkbox"/>	Aquamarine F (202)
<input type="checkbox"/>	Light Amethyst F (212)
<input type="checkbox"/>	Olivine F (228)
<input type="checkbox"/>	Rose F (209)
<input type="checkbox"/>	White Opal F (234)

4744 Flower Fancy Stone



Size
6 mm
10 mm

Colour	
<input type="checkbox"/>	Crystal F (001)
<input type="checkbox"/>	Crystal AB F (001 AB)
<input type="checkbox"/>	Aquamarine F (202)
<input type="checkbox"/>	Fuchsia F (502)
<input type="checkbox"/>	Light Rose F (223)
<input type="checkbox"/>	Light Siam F (227)
<input type="checkbox"/>	Peridot F (214)
<input type="checkbox"/>	Violet F (371)

4745 Star Fancy Stone



Size
5 mm
10 mm

Colour	
<input type="checkbox"/>	Crystal F (001)
<input type="checkbox"/>	Crystal AB F (001 AB)
<input type="checkbox"/>	Crystal Bermuda Blue F (001 BBL)
<input type="checkbox"/>	Crystal Golden Shadow F (001 GSHA)
<input type="checkbox"/>	Crystal Silver Shade F (001 SSHA)
<input type="checkbox"/>	Crystal Vitrail Light F (001 VL)
<input type="checkbox"/>	Crystal Vitrail Medium F (001 VM)
<input type="checkbox"/>	Jet (280)
<input type="checkbox"/>	Jet Hematite (280 HEM)

4756 Galactic Flat Fancy Stone



Size
19x11.5 mm
27x16 mm
39x23.5 mm

Colour	
<input type="checkbox"/>	Crystal F (001)
<input type="checkbox"/>	Crystal Golden Shadow F (001 GSHA)
<input type="checkbox"/>	Crystal Red Magma F (001 REDM)
<input type="checkbox"/>	Crystal Sahara F (001 SAH)
<input type="checkbox"/>	Crystal Silver Shade F (001 SSHA)
<input type="checkbox"/>	Jet (280)
<input type="checkbox"/>	Jet Hematite (280 HEM)

Fancy Stones & Settings

Fancy Stones & Settings

4757 Galactic Fancy Stone



Colour		Size
<input type="checkbox"/> Crystal F (001)		14x8.5 mm
<input type="checkbox"/> Crystal Golden Shadow F (001 GSHA)	New!	19x11.5 mm
<input type="checkbox"/> Crystal Silver Shade F (001 SSHA)	New!	
<input type="checkbox"/> Jet (280)		
<input type="checkbox"/> Jet Hematite (280 HEM)	New!	
<input type="checkbox"/> Aquamarine F (202)		
<input type="checkbox"/> Light Colorado Topaz F (246)		
<input type="checkbox"/> Light Rose F (223)		
<input type="checkbox"/> Tanzanite F (539)		
<input type="checkbox"/> White Opal F (234)		

4759 Cosmic Flat Fancy Stone

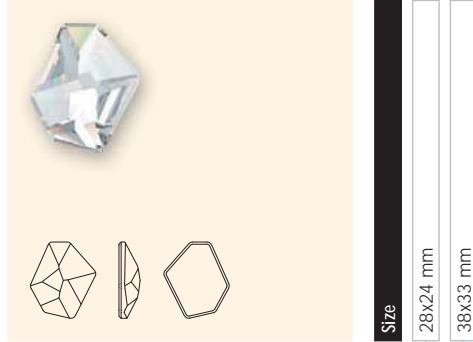

Colour		Size
<input type="checkbox"/> Crystal F (001)		28x24 mm
<input type="checkbox"/> Crystal Golden Shadow F (001 GSHA)		38x33 mm
<input type="checkbox"/> Crystal Sahara F (280)		
<input type="checkbox"/> Crystal Silver Shade F (001 SSHA)		
<input type="checkbox"/> Jet (280)		
<input type="checkbox"/> Jet Hematite (280 HEM)	New!	

4760 Calypso Fancy Stone

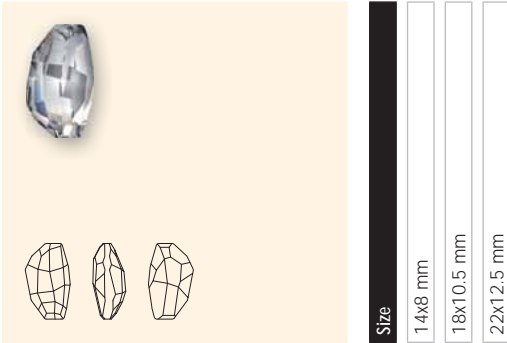

Colour		Size
<input type="checkbox"/> Crystal F (001)		14x8 mm
<input type="checkbox"/> Crystal AB F (001 AB)		18x10.5 mm
<input type="checkbox"/> Crystal Copper F (001 COP)		22x12.5 mm
<input type="checkbox"/> Crystal Golden Shadow F (001 GSHA)		
<input type="checkbox"/> Crystal Red Magma F (001 REDM)		
<input type="checkbox"/> Crystal Silver Shade F (001 SSHA)		
<input type="checkbox"/> Jet (280)		
<input type="checkbox"/> Jet Nut (280 NUT)		
<input type="checkbox"/> Aquamarine F (202)		
<input type="checkbox"/> Light Rose F (223)		
<input type="checkbox"/> Olivine F (228)		
<input type="checkbox"/> Provence Lavender F (283)		

4760/S ^{New!}

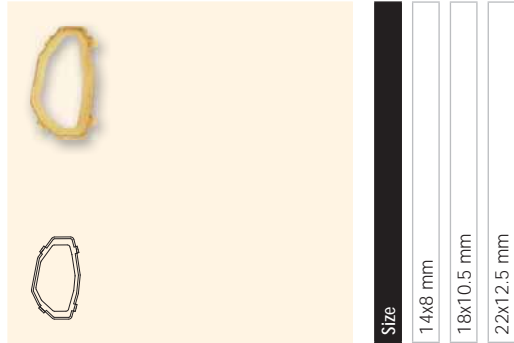

Ring/Hole, Back Configuration		Size
<input type="checkbox"/> 00 C = No ring/hole, closed		14x8 mm
<input type="checkbox"/> H2 O = 4 holes/2 each side, open		18x10.5 mm
		22x12.5 mm

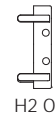

Fancy Stones & Settings

4787 Divine Rock Flat Fancy Stone



Colour		19x13 mm	27x19 mm
	Crystal F (001)	<input checked="" type="checkbox"/>	<input checked="" type="checkbox"/>
	Crystal Golden Shadow F (001 GSHA)	<input checked="" type="checkbox"/>	<input checked="" type="checkbox"/>
	Crystal Red Magma F (001 REDM)	<input checked="" type="checkbox"/>	<input checked="" type="checkbox"/>
	Crystal Silver Shade F (001 SSHA)	<input checked="" type="checkbox"/>	<input checked="" type="checkbox"/>
	Jet (280)	<input checked="" type="checkbox"/>	<input checked="" type="checkbox"/>
	Aquamarine F (202)	<input checked="" type="checkbox"/>	<input checked="" type="checkbox"/>
	Jonquil F (213)	<input checked="" type="checkbox"/>	<input checked="" type="checkbox"/>
	Light Rose F (223)	<input checked="" type="checkbox"/>	<input checked="" type="checkbox"/>
	Montana F (207)	<input checked="" type="checkbox"/>	<input checked="" type="checkbox"/>
	Topaz F (203)	<input checked="" type="checkbox"/>	<input checked="" type="checkbox"/>

4790 Wing Fancy Stone



Colour		18x7.5 mm	23x10 mm	32x13.5 mm
	Crystal F (001)	<input checked="" type="checkbox"/>	<input checked="" type="checkbox"/>	<input checked="" type="checkbox"/>
	Crystal AB F (001 AB)	<input checked="" type="checkbox"/>	<input checked="" type="checkbox"/>	<input checked="" type="checkbox"/>
	Crystal Copper F (001 COP)	<input checked="" type="checkbox"/>	<input checked="" type="checkbox"/>	<input checked="" type="checkbox"/>
	Crystal Golden Shadow F (001 GSHA)	<input checked="" type="checkbox"/>	<input checked="" type="checkbox"/>	<input checked="" type="checkbox"/>
	Crystal Red Magma F (001 REDM)	<input checked="" type="checkbox"/>	<input checked="" type="checkbox"/>	<input checked="" type="checkbox"/>
	Crystal Silver Shade F (001 SSHA)	<input checked="" type="checkbox"/>	<input checked="" type="checkbox"/>	<input checked="" type="checkbox"/>
	Jet (280)	<input checked="" type="checkbox"/>	<input checked="" type="checkbox"/>	<input checked="" type="checkbox"/>
	Aquamarine F (202)	<input checked="" type="checkbox"/>	<input checked="" type="checkbox"/>	<input checked="" type="checkbox"/>
	Fuchsia F (202)	<input checked="" type="checkbox"/>	<input checked="" type="checkbox"/>	<input checked="" type="checkbox"/>
	Light Rose F (223)	<input checked="" type="checkbox"/>	<input checked="" type="checkbox"/>	<input checked="" type="checkbox"/>
	Light Topaz F (226)	<input checked="" type="checkbox"/>	<input checked="" type="checkbox"/>	<input checked="" type="checkbox"/>
	Peridot F (214)	<input checked="" type="checkbox"/>	<input checked="" type="checkbox"/>	<input checked="" type="checkbox"/>
	Tanzanite F (539)	<input checked="" type="checkbox"/>	<input checked="" type="checkbox"/>	<input checked="" type="checkbox"/>
	Provence Lavender F (283)	<input checked="" type="checkbox"/>	<input checked="" type="checkbox"/>	<input checked="" type="checkbox"/>

4790/S ^{New!}

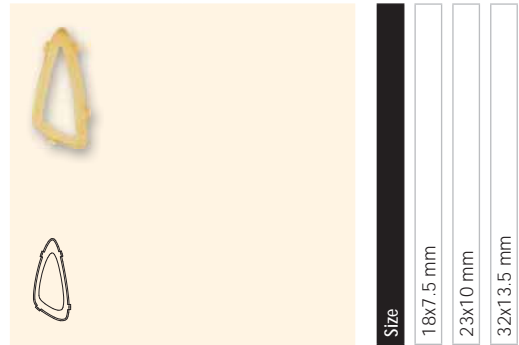

Ring/Hole, Back Configuration		18x7.5 mm	23x10 mm	32x13.5 mm
	00 C = No ring/hole, closed	<input checked="" type="checkbox"/>	<input checked="" type="checkbox"/>	<input checked="" type="checkbox"/>
	H2 O = 4 holes/2 each side, open	<input checked="" type="checkbox"/>	<input checked="" type="checkbox"/>	<input checked="" type="checkbox"/>

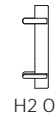
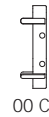

Fancy Stones & Settings

4800 Heart Fancy Stone

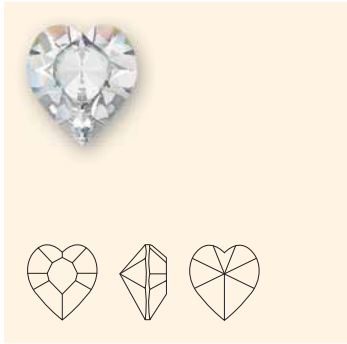

Size
5.5x5 mm
6.6x6 mm
8.8x8 mm
11x10 mm
15.4x14 mm

Colour

Crystal F (001)	■	■	■	■	■
Crystal AB F (001 AB)	■	■	■	■	■
Jet (280)	■	■	■	■	■
Amethyst F (204)	■	■	■	■	■
Aquamarine F (202)	■	■	■	■	■
Black Diamond F (215)	■	■	■	■	■
Emerald F (205)	■	■	■	■	■
Light Amethyst F (212)	■	■	■	■	■
Light Rose F (223)	■	■	■	■	■
Light Siam F (227)	■	■	■	■	■
Montana F (207)	■	■	■	■	■
Peridot F (214)	■	■	■	■	■
Rose F (209)	■	■	■	■	■
Sapphire F (206)	■	■	■	■	■
Siam F (208)	■	■	■	■	■
Topaz F (203)	■	■	■	■	■

Fancy Stones & Settings

Fancy Stones & Settings

4827

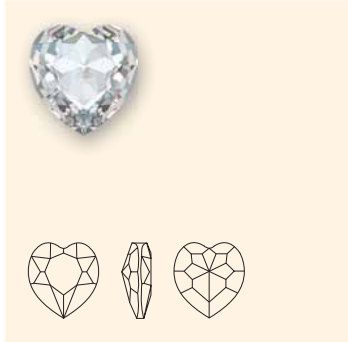

Size
28 mm

Colour

- Crystal F (001)
- Crystal AB F (001 AB)
- Crystal Bermuda Blue (001 BBL)
- Crystal Golden Shadow F (001 GSHA)
- Crystal Red Magma F (001 REDM)
- Crystal Silver Shade F (001 SSHA)
- Crystal Vitrail Medium (001 VM)
- Amethyst F (204)
- Fuchsia F (502)
- Light Amethyst F (212) *New!*
- Light Rose F (223)
- Provence Lavender F (283)

4827/S

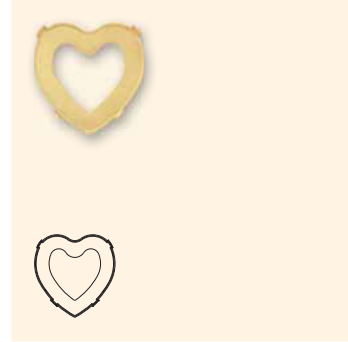

Size
28 mm

Ring/Hole, Back Configuration

- 00 C = No ring/hole, closed
- H2 O = 4 holes/2 each side, open



4831 Antique Heart Fancy Stone

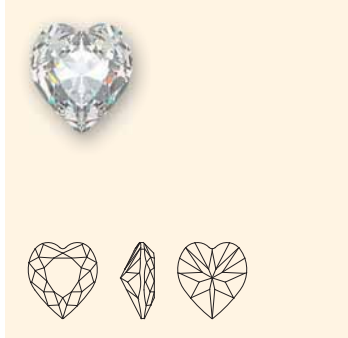

Size
5.5x5 mm
8.8x8 mm
11x10 mm

Colour

- Crystal F (001)
- Light Amethyst F (212) *New!*
- Light Rose F (223) *New!*
- Light Siam F (227) *New!*
- Rose F (209)
- Siam F (208)

4835 Mini Heart Fancy Stone

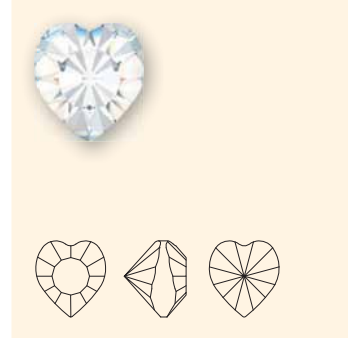

Size
3.5 mm

Colour

- Crystal F (001)
- Aquamarine F (202)
- Black Diamond F (215)
- Dark Siam F (308) *New!*
- Indian Siam F (327) *New!*
- Light Amethyst F (212)
- Light Colorado Topaz F (246)
- Light Rose F (223)
- Peridot F (214)

Fancy Stones & Settings

Fancy Stones & Settings

4841

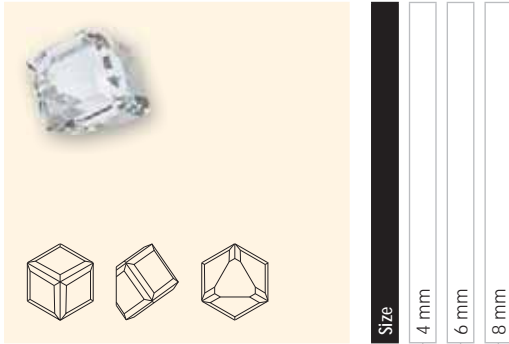

Colour	4 mm	6 mm	8 mm
Crystal CAL VZ SI (001)	■	■	■
Crystal AB CAL VZ SI (001 AB)	■	■	■
Crystal Bermuda Blue Z (001 BBL)	■	■	■
Crystal Golden Shadow CAL VZ SI (001 GSHA)	■	■	■
Crystal Heliotrope Z (001 HEL)	■	■	■
Crystal Vitrail Light Z (001 VL)	■	■	■
Crystal Vitrail Medium Z (001 VM)	■	■	■
Aquamarine CAL VZ SI (202)	■	■	■
Light Rose CAL VZ SI (223)	■	■	■
Light Siam CAL VZ SI (227)	■	■	■
Peridot CAL VZ SI (214)	■	■	■
Violet CAL VZ SI (371)	■	■	■

4842 Pyramid Fancy Stone

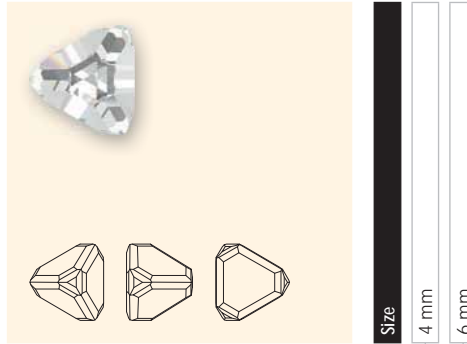

Colour	4 mm	6 mm
Crystal CAL V SI (001)	■	■

4854 Space Cut Fancy Stone

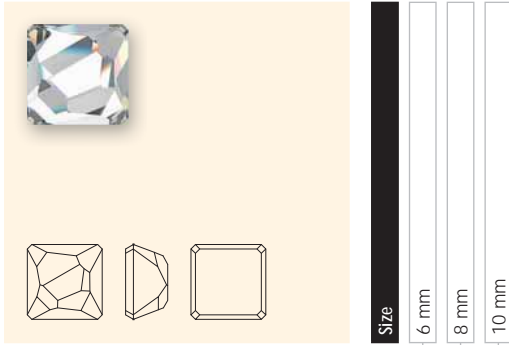

Colour	6 mm	8 mm	10 mm
Crystal CAL V SI (001)	■	■	■
Crystal AB CAL V SI (001 AB)	■	■	■
Crystal Golden Shadow CAL V SI (001 GSHA)	■	■	■
Jet (280)	■	■	■
Jet Hematite (280 HEM)	■	■	■

4869

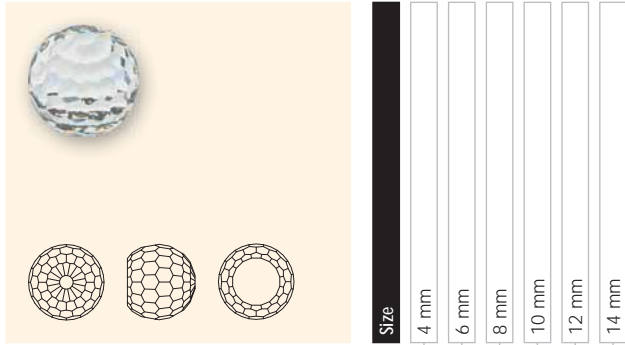

Colour	4 mm	6 mm	8 mm	10 mm	12 mm	14 mm
Crystal CAL VZ SI (001)	■	■	■	■	■	■
Crystal AB CAL VZ SI (001 AB)	■	■	■	■	■	■
Crystal Vitrail Light Z (001 VL)	■	■	■	■	■	■
Crystal Vitrail Medium Z (001 VM)	■	■	■	■	■	■
Aquamarine CAL VZ SI (202)	■	■	■	■	■	■
Light Rose CAL VZ SI (223)	■	■	■	■	■	■
Light Siam CAL VZ SI (227)	■	■	■	■	■	■
Violet CAL VZ SI (371)	■	■	■	■	■	■
White Opal CAL VZ SI (234)	■	■	■	■	■	■

Article Size	Packing Unit = Minimum Order Quantity in Pieces	Average Net Weight in Gram per Packing Unit Crystal (001)	Average Gross Weight in Gram per Packing Unit Crystal (001)
4120			
6x4 mm	360	26.1	37.0
8x6 mm	180	37.4	46.5
14x10 mm	144	142.5	166.1
18x13 mm	48	94.0	114.6
25x18 mm	24	127.4	152.8
4120/S			
14x10 mm	144		86.0
18x13 mm	48		49.5
4127			
30x22 mm	24	145.3	190.4
39x28 mm	12	189.8	209.4
4127/S			
30x22 mm	24		53.0
4128*			
6x4 mm	360	26.8	37.6
8x6 mm	360	76.5	87.3
10x8 mm	144	59.9	80.2
14x10 mm	144	105.6	129.2
4128/S*			
14x10 mm	144		86.0
4137			
15x11 mm	72	48.2	66.4
22x16 mm	24	44.2	64.2
33x24 mm	18	117.5	144.2
4139			
14 mm	72	53.2	82.7
20 mm	24	46.7	78.7
30 mm	18	124.6	153.0
4161			
15x5 mm	72	24.7	42.8
21x7 mm	48	59.9	84.9
27x9 mm	24	55.1	83.5
4161/S			
15x5 mm	72		24.3
21x7 mm	48		27.0
27x9 mm	24		21.5
4200			
11x3 mm	360	28.6	39.4
15x4 mm	144	26.2	37.1
4227			
32x17 mm	24	100.8	123.4
4227/S			
32x17 mm	24		48.0
4228			
4x2 mm	720	9.2	18.3
5x2.5 mm	720	18.9	28.0
6x3 mm	720	30.5	39.6
8x4 mm	360	32.9	42.0
10x5 mm	360	60.7	72.1
15x7 mm	144	63.9	88.1

* Available as of September 2010! Until September 2010 art. 4100 is still available (please refer to former Collection for product details).



Fancy Stones & Settings

Article Size	Packing Unit = Minimum Order Quantity in Pieces	Average Net Weight in Gram per Packing Unit Crystal (001)	Average Gross Weight in Gram per Packing Unit Crystal (001)
4320			
6x4 mm	360	25.7	34.8
8x6 mm	180	30.7	39.8
10x7 mm	144	48.6	68.9
14x10 mm	144	126.6	150.2
18x13 mm	48	85.2	105.8
4320/S			
18x13 mm	48		46.0
4327			
30x20 mm	24	135.4	180.5
40x27 mm	12	168.7	193.4
4327/S			
30x20 mm	24		51.5
4328			
6x3.6 mm	720	40.0	50.5
8x4.8 mm	360	42.1	53.0
10x6 mm	144	29.2	50.5
13x7.8 mm	144	65.1	88.3
4335			
3.5 mm	1,440	43.3	49.2
4370			
11x10 mm	144	82.8	100.9
15.5x14 mm	72	107.3	127.4
20x18 mm	48	149.5	170.0
4428			
2 mm	1,440	10.3	21.0
3 mm	1,440	36.7	50.5
4 mm	1,440	90.8	101.8
5 mm	360	43.2	53.5
6 mm	360	74.1	78.4
8 mm	144	70.7	85.9
4428/S			
6 mm	360		50.0
8 mm	144		45.5
4437			
14 mm	72	48.2	78.7
20 mm	30	57.8	86.1
30 mm	18	105.5	159.8
4439			
14 mm	72	88.0	111.6
20 mm	24	80.4	123.0
30 mm	12	127.6	145.8
4447			
6 mm	360	73.2	84.0
8 mm	144	59.8	80.2
10 mm	144	112.1	135.4
12 mm	72	98.5	118.7
4447/S			
6 mm	360		50.0
8 mm	144		47.0
10 mm	144		70.5
12 mm	72		56.0

Fancy Stones & Settings

Article Size	Packing Unit = Minimum Order Quantity in Pieces	Average Net Weight in Gram per Packing Unit Crystal (001)	Average Gross Weight in Gram per Packing Unit Crystal (001)
4461			
8 mm	144	56.9	77.2
12 mm	72	84.4	103.4
16 mm	72	214.4	238.0
4461/S			
12 mm	72		52.8
16 mm	72		92.0
4470			
10 mm	144	91.6	111.9
12 mm	72	74.7	92.9
18 mm	48	170.3	190.9
4470/S			
10 mm	144		54.5
12 mm	72		53.3
4500			
3x2 mm	1,440	20.5	32.0
6x2 mm	720	18.4	27.5
10x3 mm	360	36.6	47.6
4501			
4x2 mm	720	16.8	25.9
5x2 mm	720	18.1	27.2
5x2.5 mm	720	20.9	30.0
7x3 mm	720	60.2	71.1
10x5 mm	360	96.2	106.9
4501/S			
7x3 mm	720		58.0
4502			
3x1 mm	720	2.2	11.4
4527			
8x6 mm	144	44.9	55.8
14x10 mm	72	95.8	114.0
18x13 mm	72	206.7	230.4
4527/S			
8x6 mm	144		45.5
14x10 mm	72		60.3
4547			
15x5 mm	72	31.3	49.4
21x7 mm	48	54.6	88.1
24x8 mm	48	81.6	114.6
30x10 mm	24	82.2	99.7
4547/S			
15x5 mm	72		36.8
21x7 mm	48		43.5
24x8 mm	48		50.5
30x10 mm	24		39.0
4565			
14x10 mm	72	71.5	88.9
18x13 mm	48	101.2	121.8
4581			
24x16 mm	20	118.9	146.7
4582			
24x16 mm	20	112.2	139.4

Fancy Stones & Settings

Article Size	Packing Unit = Minimum Order Quantity in Pieces	Average Net Weight in Gram per Packing Unit Crystal (001)	Average Gross Weight in Gram per Packing Unit Crystal (001)
4583			
24x16 mm	20	127.2	155.0
4584			
24x16 mm	20	107.1	135.8
4600			
6x4 mm	360	40.9	51.8
8x6 mm	144	41.2	52.2
10x8 mm	144	84.0	104.0
12x10 mm	144	146.7	170.3
4610			
14x10 mm	144	171.3	194.9
18x13 mm	48	124.9	145.5
20x15 mm	24	88.5	105.8
4610/S			
14x10 mm	144		104.5
18x13 mm	48		66.0
4627			
27x18.5 mm	24	125.3	170.8
37x25.5 mm	12	170.7	197.8
4627/S			
27x18.5 mm	24		54.0
4675			
23 mm	24	146.8	191.9
4704			
5 mm	720	58.5	67.8
4722			
4 mm	480	12.0	21.1
6 mm	180	16.4	25.5
8 mm	144	29.0	48.1
10 mm	144	61.4	84.4
4727			
23 mm	24	131.8	176.8
4727/S			
23 mm	24		41.0
4735			
3.5 mm	1,440	45.5	48.7
4737			
14 mm	48	36.2	53.9
20 mm	20	55.2	73.5
30 mm	12	89.4	109.2
4739			
14x11 mm	144	120.3	146.9
20x16 mm	72	168.0	197.0
4744			
6 mm	720	62.3	72.8
10 mm	288	126.0	158.1
4745			
5 mm	720	35.6	46.4
10 mm	144	48.5	71.3

Fancy Stones & Settings

Article Size	Packing Unit = Minimum Order Quantity in Pieces	Average Net Weight in Gram per Packing Unit Crystal (001)	Average Gross Weight in Gram per Packing Unit Crystal (001)
4756			
19x11.5 mm	96	112.5	149.4
27x16 mm	40	127.2	169.2
39x23.5 mm	24	221.0	256.2
4757			
14x8.5 mm	96	64.3	83.5
19x11.5 mm	96	152.7	181.9
4759			
28x24 mm	20	102.5	128.7
38x33 mm	12	153.7	178.7
4760			
14x8 mm	144	132.6	145.8
18x10.5 mm	96	168.7	204.7
22x12.5 mm	36	126.6	154.2
4760/S			
14x8 mm	144		105.1
18x10.5 mm	96		107.0
22x12.5 mm	36		59.4
4787			
19x13 mm	48	108.5	127.0
27x19 mm	30	208.4	240.7
4790			
18x7.5 mm	108	72.3	97.1
23x10 mm	36	48.2	71.9
32x13.5 mm	30	105.5	139.5
4790/S			
18x7.5 mm	108		85.9
23x10 mm	36		47.7
32x13.5 mm	30		75.5
4800			
5.5x5 mm	360	39.0	49.7
6.6x6 mm	360	67.2	78.0
8.8x8 mm	288	111.4	138.1
11x10 mm	144	107.3	127.4
15.4x14 mm	72	128.7	149.3
4827			
28 mm	24	214.9	253.3
4827/S			
28 mm	24		55.5
4831			
5.5x5 mm	360	26.5	37.3
8.8x8 mm	144	40.0	60.4
11x10 mm	144	80.1	101.5
4835			
3.5 mm	1,440	48.2	54.0
4841			
4 mm	288	45.3	66.6
6 mm	144	77.2	95.3
8 mm	72	89.2	107.4
4842			
4 mm	288	31.6	52.9
6 mm	288	109.9	140.7



Fancy Stones & Settings

Article Size	Packing Unit = Minimum Order Quantity in Pieces	Average Net Weight in Gram per Packing Unit Crystal (001)	Average Gross Weight in Gram per Packing Unit Crystal (001)
4854			
6 mm	288	59.9	80.2
8 mm	144	72.3	90.3
10 mm	72	69.9	87.6
4869			
4 mm	480	36.2	45.3
6 mm	180	47.2	56.4
8 mm	144	90.8	109.0
10 mm	72	88.3	105.3
12 mm	48	109.3	129.6
14 mm	72	269.4	296.8



Photography: Christoph Sagel, Robert Striegl
Content is subject to change without notice. Errors and misprints excepted.
SWAROVSKI AG · P.O. Box 567 · 9495 Triesen · Liechtenstein

© 2010 Swarovski AG. All rights reserved. Partial or total publication, transmission, copy or other duplication of texts, graphics, pictures etc. which are to be found in this publication is forbidden without special consent by Swarovski AG.